

IR RECEIVER MODULE for Surface Mount Assembly

Description

The SDR2140 is miniaturized receiver for infrared remote control systems. PIN diode and preamplifier are assembled on lead frame, the epoxy package is designed as IR filter.

The demodulated output signal can directly be decoded by a microprocessor. The main benefit is the reliable function even in disturbed ambient and the protection against uncontrolled output pulses.

Features

- Photo detector and Preamplifier in one package
- Internal filter for RCM frequency
- TTL and CMOS compatibility
- Output active low
- Low current dissipation
- Suitable burst length • 10 cycles/burst
- Lead-Free component in accordance with RoHS directives

Special Features

- Enhanced immunity against all kinds of disturbance light
- No occurrence of disturbance pulses at the output

Applications

TV, VTR, Acoustic Devices, Air Conditioner, Car Stereo Units, Computers, Interior controlling appliances, and all appliances that require remote controlling

Block Diagram

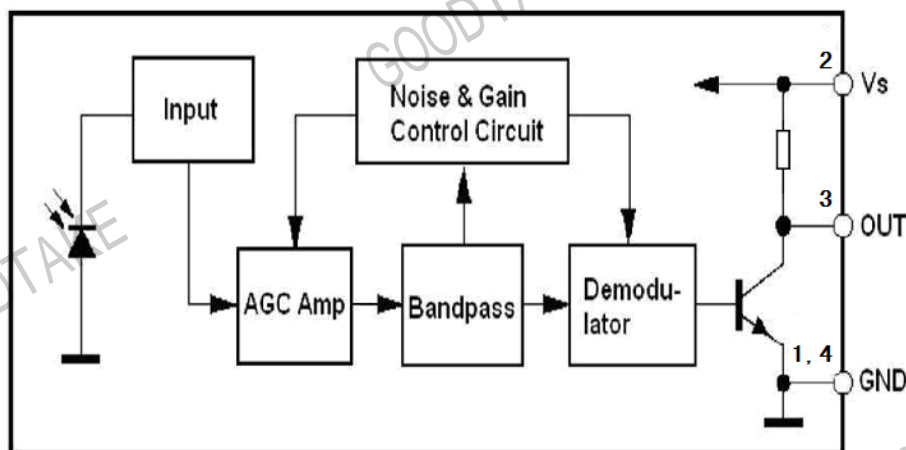

Application Circuit

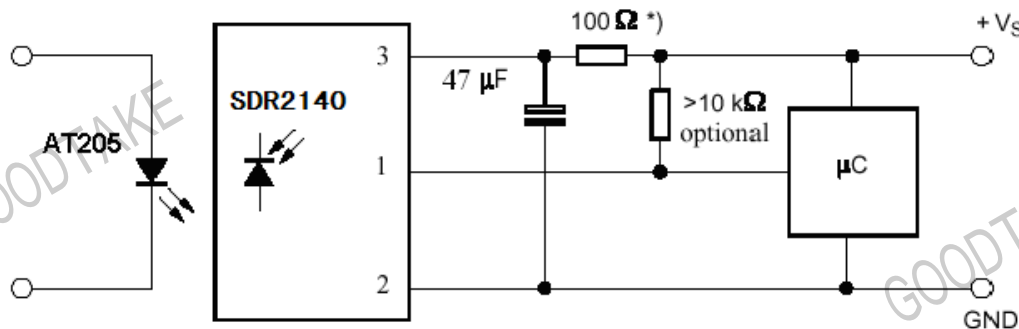

*) recommended to suppress power supply disturbance

Absolute Maximum Ratings

Tamb = 25 °C

Parameter	Test Conditions	Symbol	Value	Unit
Supply Voltage	(Pin 3)	Vs	6.0	V
Supply Current	(Pin 3)	Is	2	mA
Output Voltage	(Pin 1)	Vo	6.0	V
Storage Temperature Range		Tstg	-30...+85	°C
Operating Temperature Range		Tamb	-25...+85	°C
Power Consumption	(Tamb ≤ 85 °C)	ptot	10	mW
Soldering Temperature	t ≤ 5s	Tsd	260	°C

Basic Characteristics

Tamb = 25 °C

Parameter	Test Conditions	Symbol	Min	Typ	Max	Unit
Supply Current (Pin3)	Vs = 5V, Ev = 0	ISD	0.25	0.5	0.9	mA
Supply Voltage (Pin3)		Vs	2.5		5.5	V
Transmission Distance	IR diode AT205, IF = 400 mA	d	20			m
Output Voltage High (Pin1)	Vs = 5V Cycle 1.2mS , 50% duty	VOsh	45			V
Output Voltage Low (Pin1)		VOsL			250	mV
Level Output Pulse Width	Burst Wave= 600µs , Cycle 1.2mS , 50% duty	TWH	400		800	µs
Level Output Pulse Width		TWL	400		800	µs
Carrier frequency		fo		40		kHz
Peak Wavelength		•		940		nm
Directivity	Angle of half transmission distance	• 1/2		±45		deg

Package Outline

Dimensions in mm: tolerance ± 0.3 mm

GOODTAKE

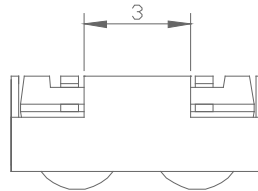

GOODTAKE

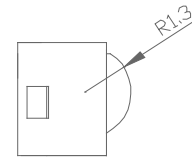
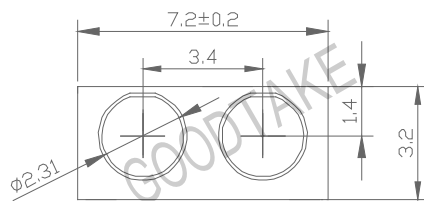
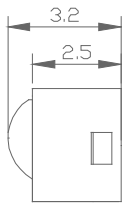

GOODTAKE

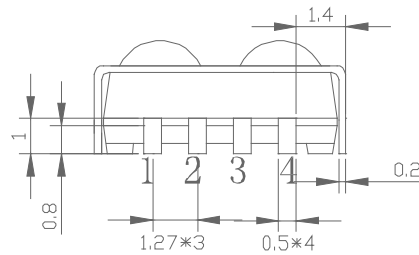

- 1. GND
- 2. VS
- 3. OUT
- 4. GND

GOODTAKE

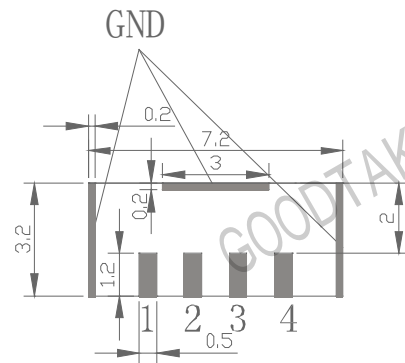

- 1. GND
- 2. VS
- 3. OUT
- 4. GND

Pin Layout

GOODTAKE

GOODTAKE

GOODTAKE