

VISIBLE LIGHT EMITTING DIODE

DATA SHEET

MODEL NO: GT3-4R02D09G

REV. : 2.0

DATE : 11-MAY.-2009

■ DESCRIPTIONS:

- 3mm Round lamp
- Lens color: Red Diffused
- Emitting Color: Bright Red
- No Stopper
- Dice Material: GaAlAs/GaAs

■ APPLICATIONS:

- TV set
- Monitor
- Telephone
- Computer
- circuit board

■ ABSOLUTE MAXIMUM RATINGS (Tamb=25,unless otherwise specified)

Parameter	Test condition	Symbol	Ratings	Unit
Forward Current		IF	30	mA
Power Dissipation		PD	75	mW
Peak Forward Current	tp/T=0.1, tp=100μs	IFP	100	mA
Reverse voltage		VR	5	V
Operating Temperature		Topr	-40~+85	°C
Storage Temperature		Tstg	-40~+100	°C
Soldering Temperature		Tsol	260°C for 5 sec Max (2mm from Body)	

Basic Characteristics (Tamb=25, unless otherwise specified)

Parameter	Symbol	Min.	Type	Max.	Unit	Test Condition
Forward Voltage	VF		1.8	2.5	V	IF=20mA
Luminous Intensity	Iv	15	35		mcd	IF=20mA
Reverse Current	IR			10	μA	VR=5V
Peak Wavelength	λp		660		nm	IF=20mA
Dominant Wavelength	λp		658		nm	IF=20mA
View Angle	2θ1/2		60		deg	IF=20mA

● Dimensions:

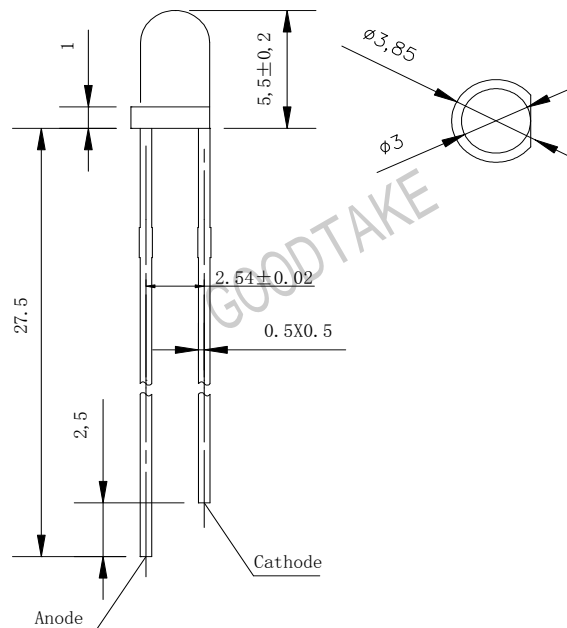

NOTE: 1. All dimensions are in millimeter, tolerance is ±0.5 unless otherwise noted.
 2. Epoxy meniscus extends ≤1 mm down to the lead is allowed.

■ **Typical electro-optical characteristics curves**

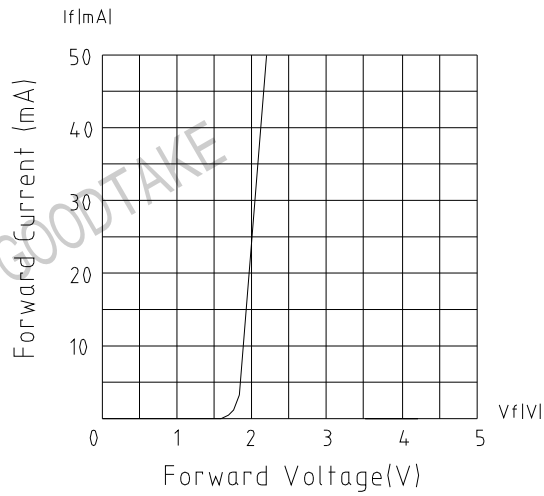

Fig.1 forward Current vs. Forward Voltage

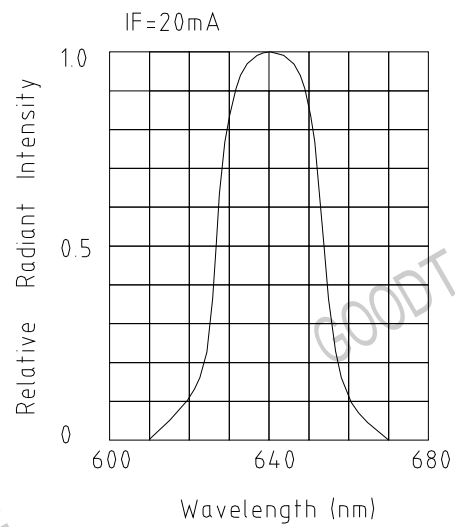

Fig.2 Spectral Distribution

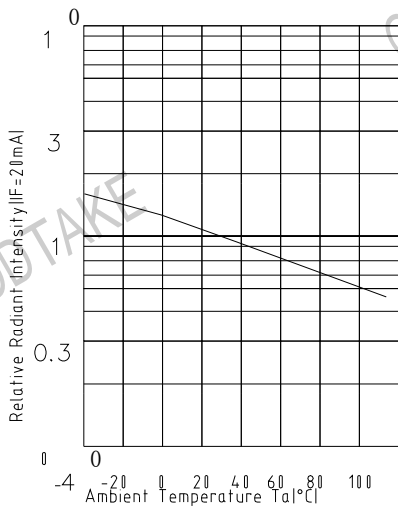

Fig.3 Relative Radiant Intensity Vs Ambient Temperature

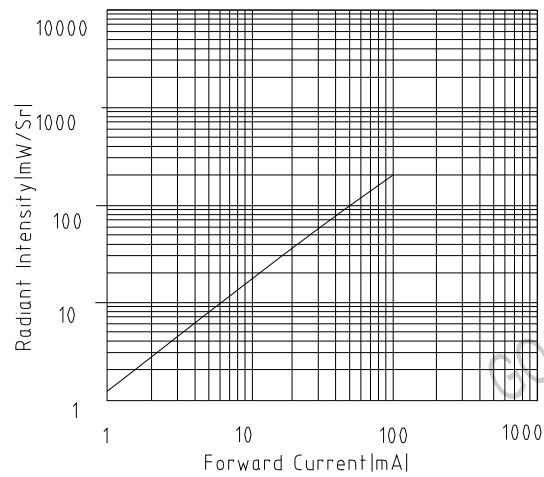

Fig.4 Forward Current Vs Radiant Intensity

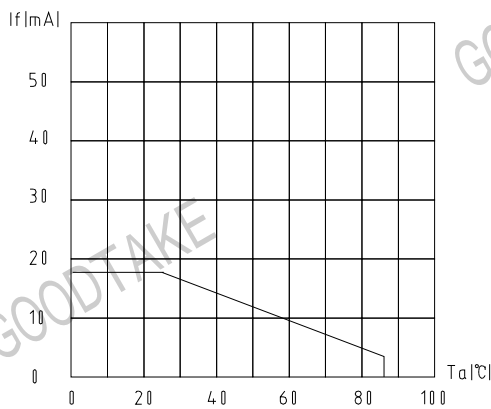

Fig.5 Maximum Forward Current Vs Ambient Temperature

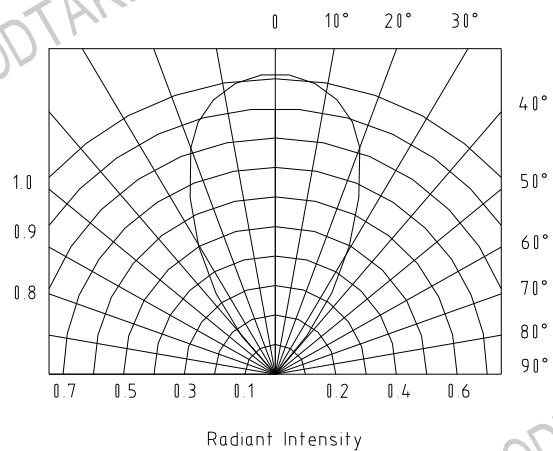

Fig.6 Angle Vs Radiant Intensity