

INFRARED EMITTING DIODE

- **Descriptions:**

AT225S-14-100 is an infrared 830 nm emitting diode with high radiant power and high speed, molded in a clear plastic package .

- **Features:**

1. Package type: leaded.
2. Peak wavelength: $\lambda_p = 830\text{nm}$.
3. High radiant intensity.
4. Angle of half intensity
5. Low forward voltage.
6. Suitable for high pulse current operation.
7. High modulation bandwidth.
8. Good spectral matching to Si photodetectors.
9. Lead (Pb)-Free component in accordance with RoHS.

- **Applications:**

1. Free air transmission system.
2. Security System.
3. Infrared applied system
4. Night viewing.

- **Internal Circuit:**

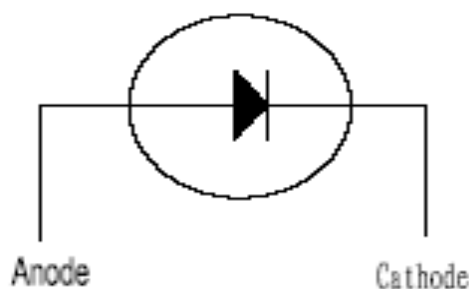

● **Absolute Maximum Ratings:**

Tamb=25,unless otherwise specified

Parameter	Test condition	Symbol	Ratings	Unit
Continuous Forward Current		IF	100	mA
Power Dissipation		PD	150	mW
Peak Forward Current	tp/T=0.5,tp=100μs	IFP	1.2	A
Reverse voltage		VR	5	V
Operating Temperature		Topr	-40~+85	℃
Storage Temperature		Tstg	-40~+100	℃
Soldering Temperature		Tsol	260℃ for 6 sec Max (2mm from Body)	

● **Basic Characteristics**

Tamb=25,unless otherwise specified

Parameter	Symbol	Min.	Type	Max.	Unit	Test Condition
Radiant Intensity	Ie	-	35	-	mW/sr	IF=100mA
Forward Voltage	VF		1.51	1.7	V	IF=100mA
Reverse Current	IR			10	μA	VR=5V
Peak Wavelength	λp	810	830	860		IF=100mA
Spectral Line Half-Width	Δλ		40		nm	IF=100mA
View Angle	2θ1/2		±25		deg	IF=100mA

● **Typical Characteristics**

Tamb = 25 °C, unless otherwise specified

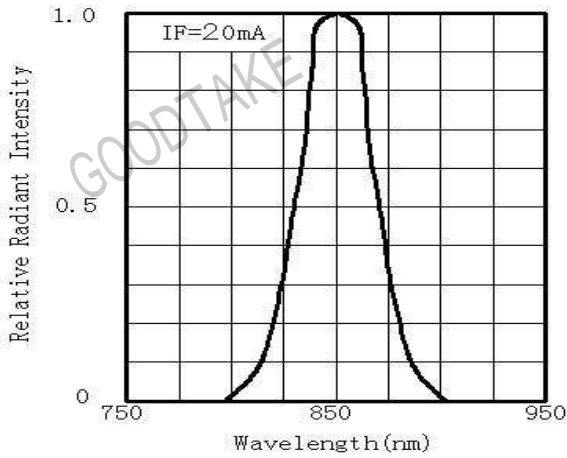

Fig.1 Spectral Distribution

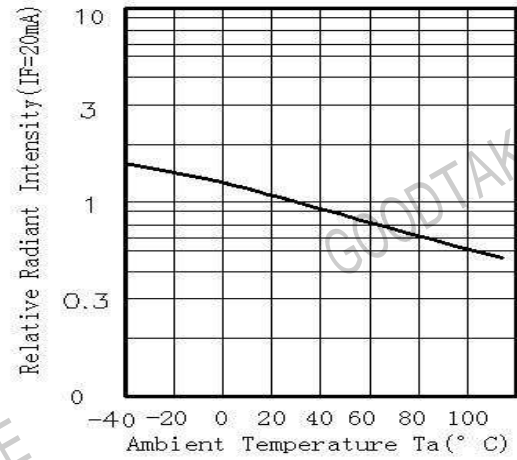

Fig.2 Relative Radiant Intensity Vs Ambient Temperature

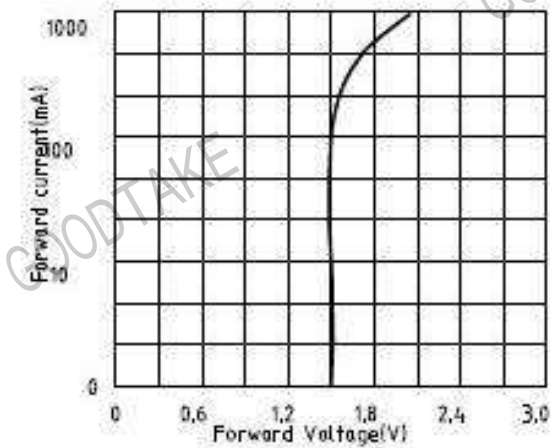

Fig.3 Forward Current Vs Forward Voltage

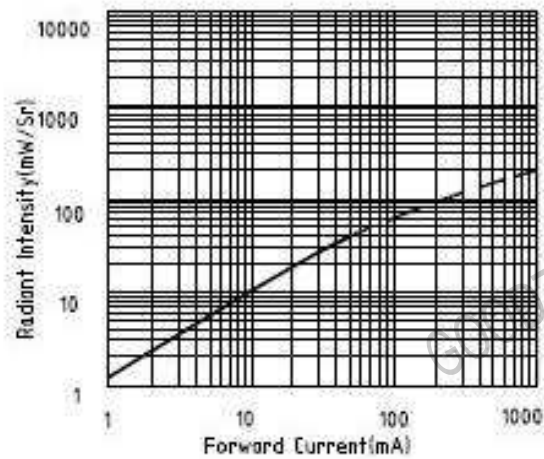

Fig.4 Forward Current Vs Radiant Intensity

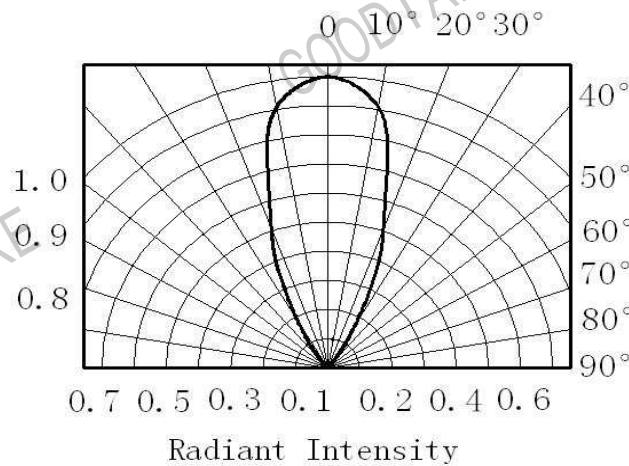
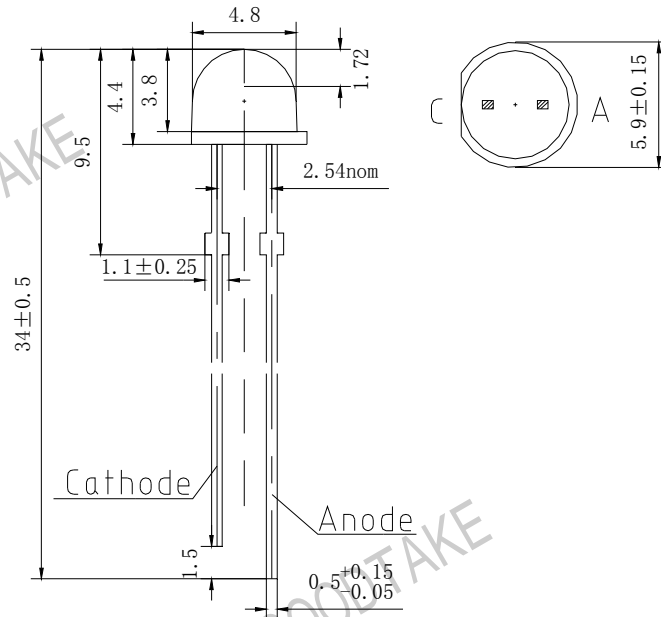

Fig.5 Angle Vs Radiant Intensity

● **Dimensions:**



NOTE: 1. All dimensions are in millimeter, tolerance is ± 0.25 unless otherwise noted.
 2. Epoxy meniscus extends ≤ 1 mm down to the lead is allowed.

● **Reliability Test Items And Conditions:**

NO	Item	Test Conditions	Test Hours/Cycle	Sample Quantity	Test Result
1	Solder Heat	TEMP: 270°C \pm 3°C	10 SEC	11 pcs	0 DEFECT
2	Temperature Cycle	H: +85°C 60min \updownarrow 10min L: -25°C 60min	16 cycles	22 pcs	0 DEFECT
3	Thermal Shock	H: +85°C 30min \updownarrow 30sec L: -25°C 30min	10 cycles	11 pcs	0 DEFECT
4	High Temperature Storage	TEMP: +85°C	1000 HRS	22 pcs	0 DEFECT
5	Low Temperature Storage	TEMP: -25°C	1000 HRS	22 pcs	0 DEFECT
6	High Temperature High Humidity Storage	85°C/93% RH	1000HRS	22 pcs	0 DEFECT