

INFRARED EMITTING DIODE

- **Descriptions:**

AT223-12-45 is an infrared 850 nm emitting diode with high radiant power and high speed, molded in a clear plastic package .

- **Features:**

1. Package type: leaded.
2. Peak wavelength: $\lambda_p = 850\text{nm}$.
3. High radiant intensity.
4. Angle of half intensity $\theta_{1/2} = \pm 11^\circ$.
5. Low forward voltage.
6. Suitable for high pulse current operation.
7. High modulation bandwidth.
8. Good spectral matching to Si photodetectors.
9. Lead (Pb)-Free component in accordance with RoHS.

- **Applications:**

1. Free air transmission system.
2. Security System.
3. Infrared applied system
4. Night viewing.

- **Internal Circuit:**

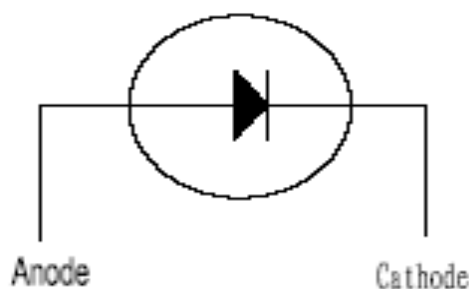

● **Absolute Maximum Ratings:**

Tamb=25,unless otherwise specified

Parameter	Test condition	Symbol	Ratings	Unit
Continuous Forward Current		IF	50	mA
Power Dissipation		PD	120	mW
Peak Forward Current	tp/T=0.5,tp=100μs	IFP	350	mA
Reverse voltage		VR	5	V
Operating Temperature		Topr	-40~+85	°C
Storage Temperature		Tstg	-40~+100	°C
Soldering Temperature		Tsol	260°C for 6 sec Max (2mm from Body)	

● **Basic Characteristics**

Tamb=25,unless otherwise specified

Parameter	Symbol	Min.	Type	Max.	Unit	Test Condition
Radiant Intensity	Ee	65		100	mW/sr	IF=50mA
Forward Voltage	VF	1.4		1.6	V	IF=50mA
Reverse Current	IR			10	μA	VR=5V
Peak Wavelength	λp	840	850	860		IF=20mA
Spectral Line Half-Width	Δλ		40		nm	IF=20mA
View Angle	2θ1/2		22		deg	IF=20mA

● **Typical Characteristics**

Tamb = 25 °C, unless otherwise specified

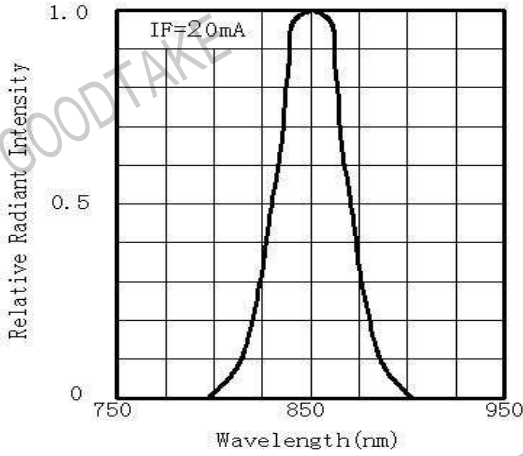

Fig.1 Spectral Distribution

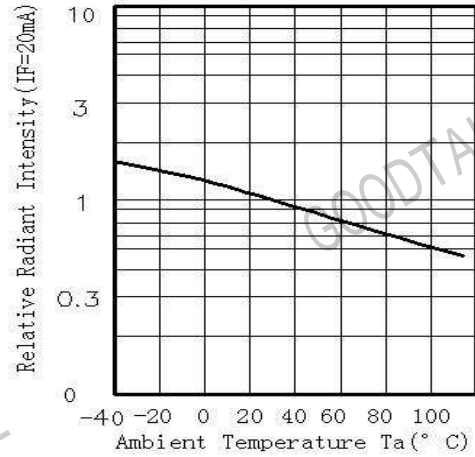

Fig.2 Relative Radiant Intensity Vs Ambient Temperature

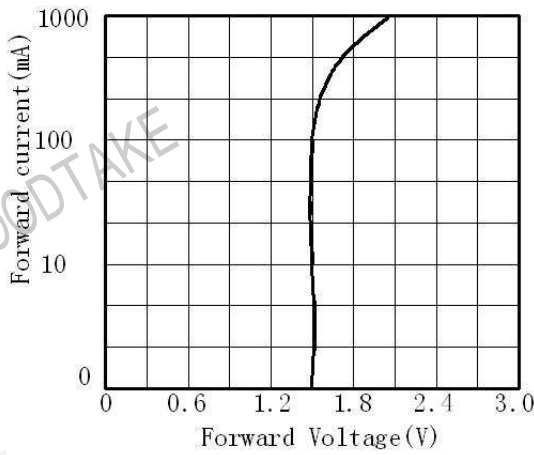

Fig.3 Forward Current Vs Forward Voltage

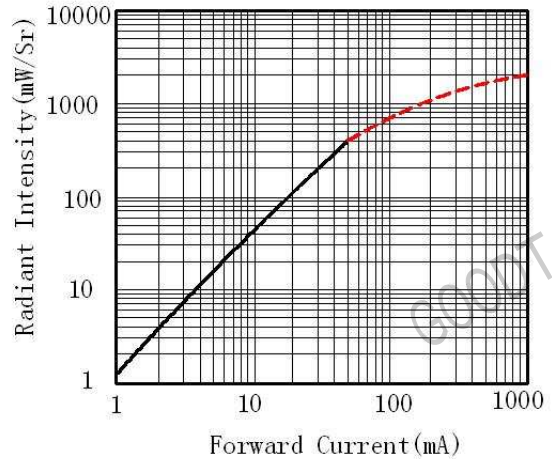

Fig.4 Forward Current Vs Radiant Intensity

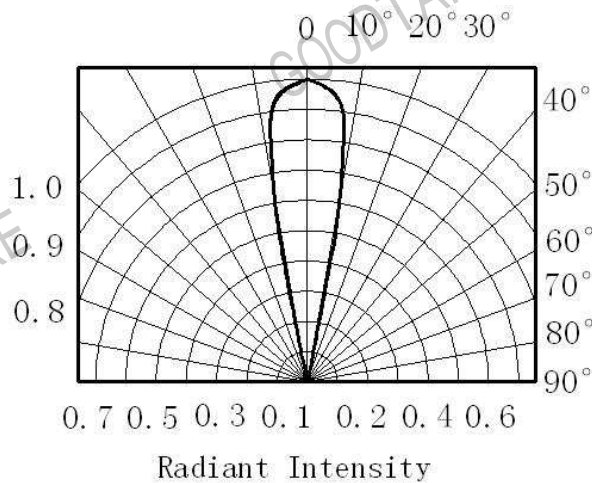
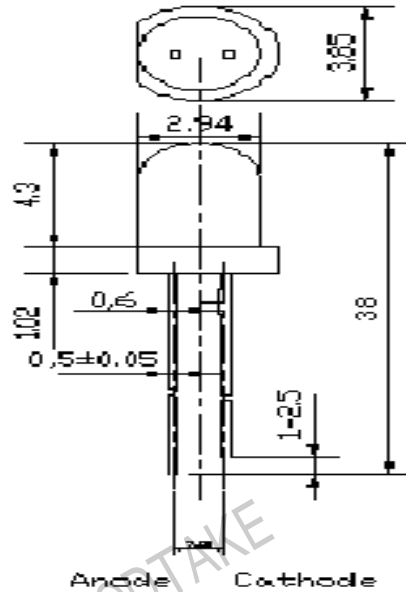

Fig.5 Angle Vs Radiant Intensity

● **Dimensions:**



NOTE: 1. All dimensions are in millimeter, tolerance is ± 0.25 unless otherwise noted.
 2. Epoxy meniscus extends ≤ 1 mm down to the lead is allowed.

● **Reliability Test Items And Conditions:**

NO	Item	Test Conditions	Test Hours/Cycle	Sample Quantity	Test Result
1	Solder Heat	TEMP: $270^{\circ}\text{C} \pm 3^{\circ}\text{C}$	10 SEC	11 pcs	0 DEFECT
2	Temperature Cycle	H: $+85^{\circ}\text{C}$ 60min \updownarrow 10min L: -25°C 60min	16 cycles	22 pcs	0 DEFECT
3	Thermal Shock	H: $+85^{\circ}\text{C}$ 30min \updownarrow 30sec L: -25°C 30min	10 cycles	11 pcs	0 DEFECT
4	High Temperature Storage	TEMP: $+85^{\circ}\text{C}$	1000 HRS	22 pcs	0 DEFECT
5	Low Temperature Storage	TEMP: -25°C	1000 HRS	22 pcs	0 DEFECT
6	High Temperature High Humidity Storage	$85^{\circ}\text{C}/93\% \text{ RH}$	1000HRS	22 pcs	0 DEFECT