

INFRARED LIGHT EMITTING DIODE

1.GENERAL DESCRIPTIONS

AT203-A-JZY is high output power AlGaAs infrared light emitting diode, mounted in clear epoxy package. It emits spectrally narrow band of radiation peaking at 940nm. And the device is matched with phototransistor, photodiode and infrared receiver module.

2.FEATURES

- 1) Wide beam angle.
- 2) Good linearity, high response speed.
- 3) High output power.
- 4) Low cost.

3.ABSOLUTE MAXIMUM RATINGS AT Ta=25°C

PARAMETER	MAXIMUM RATING	UNIT
Power Dissipation	110	mW
Peak Forward Current (300pps, 10μs pulse)	1	A
Continuous Forward Current	100	mA
Reverse Voltage	5	V
Operating Temperature Range	-40 to 85 °C	°C
Storage Temperature Range	-55 to +100°C	°C
Lead Soldering Temperature (1.6mm from body)	260 for 3 seconds	°C

4.ELECTRICAL OPTICAL CHARACTERISTICS AT Ta=25°C

PARAMETER	SYMBOL	MIN.	TYP.	MAX.	UNIT	TEST CONDITION
Radiant Intensity	I _e	3.0		5.0	mW/sr	I _F =20mA
Peak Emission Wavelength	λ _{peak}		940		nm	I _F =20mA
Spectral Line Half-Width	Δλ		50		nm	I _F =20mA
Forward Voltage	V _F		1.2	1.5	V	I _F =20mA
Reverse Current	I _R			10	μA	V _R =5V
Viewing Angle	2θ _{1/2}		50		Deg.	

5.TYPICAL ELECTRICAL/OPTICAL CHARACTERISTICS CURVES

(25°C Ambient Temperature Unless Otherwise Noted)

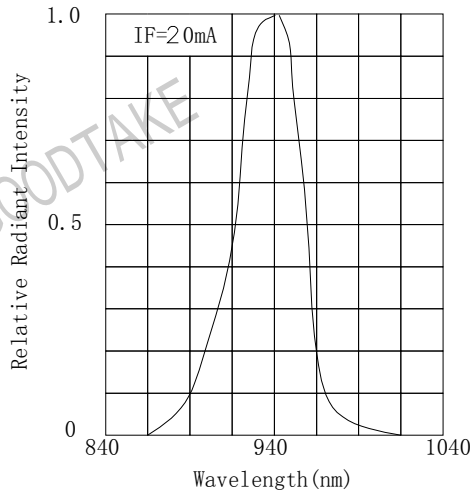

Fig.1 Spectral Distribution

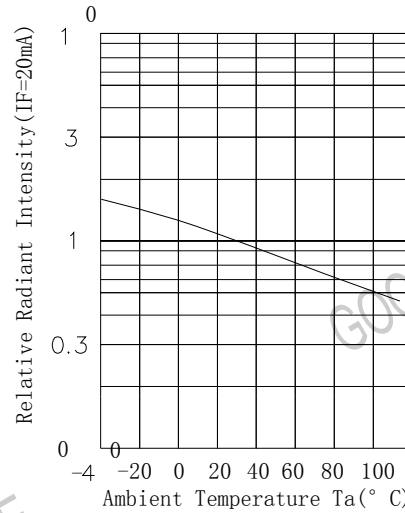

Fig.2 Relative Radiant Intensity Vs Ambient Temperature

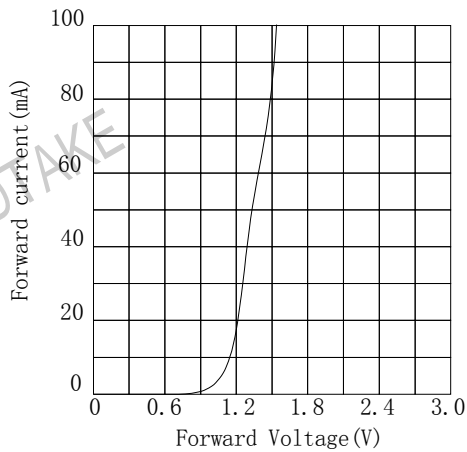

Fig.3 Forward Current Vs Forward Voltage

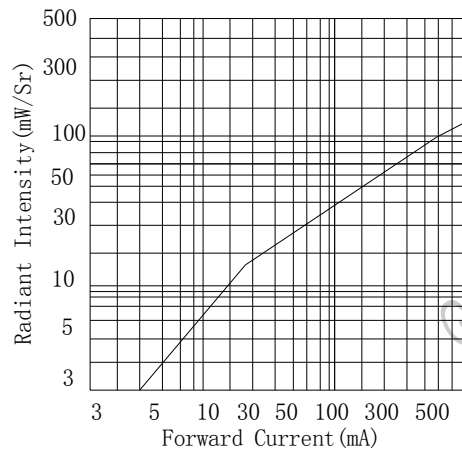

Fig.4 Forward Current Vs Radiant Intensity

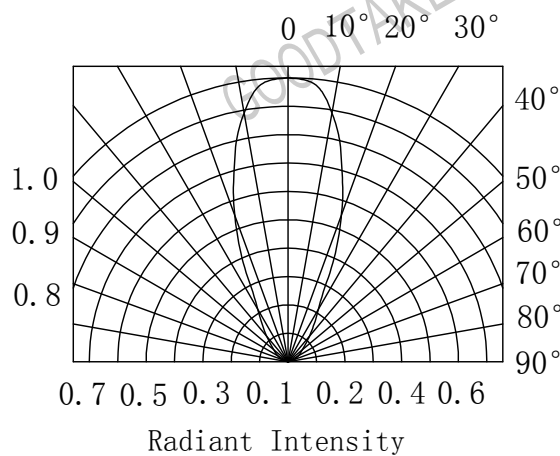
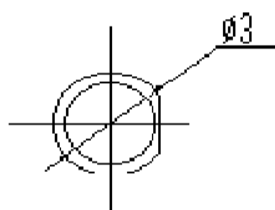
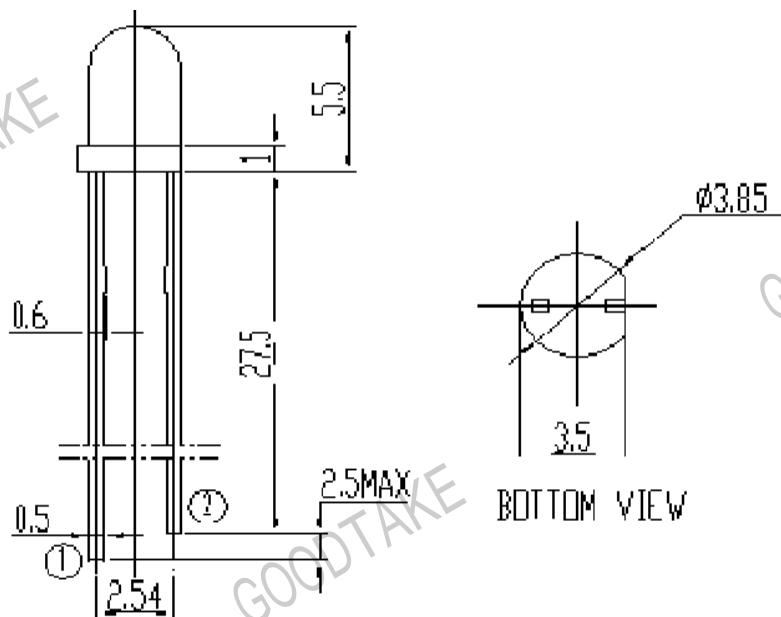

Fig.5 Angle Vs Radiant Intensity

6.DIMENSIONS



Notes

1. All dimensions are in millimeters.
2. Tolerance is ± 0.5 unless otherwise noted.
3. An epoxy meniscus may extend about "0.5mm" down the leads.